

# Installation Guide

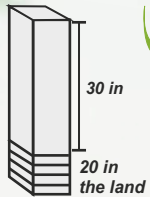

**1**  
Leave the platform 30 in above ground and at least 20 cm buried

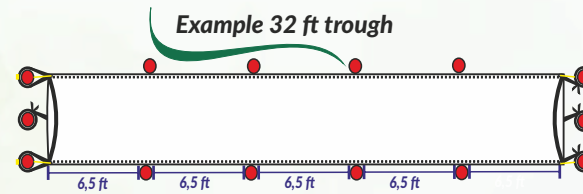
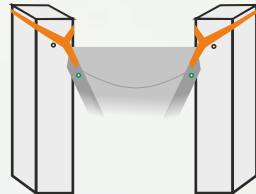

**4**  
On one side, tie the platform with the strap and at the other end stretch the trough and tie it. Note: leave the trough well stretched

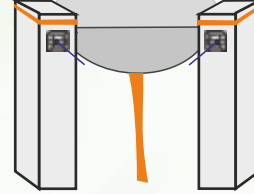

**7**  
At the other end use the ratchet to stretch the wire, leaving the trough well stretched

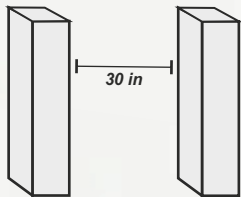

**2**  
The platforms must stay at least 30 in away from each other

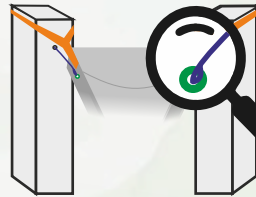

**5**  
Bend the end of the wire and pass through the eyelet hole all over the hem of the eye until it comes out through the eyelets at the other end

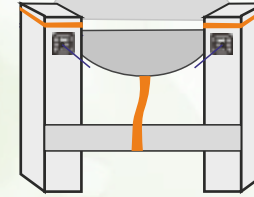

**8**  
Attach the strap to the bottom of the trough to platform or platter wooden

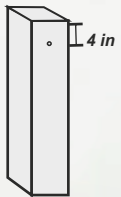

**3**  
Drill the 4 platforms in the center with 4 in below the top

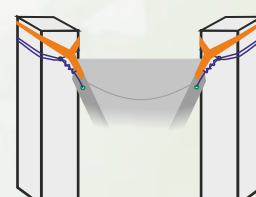

**6**  
At one end pass the wire through the hole in the platform, give a back and attach to the wire

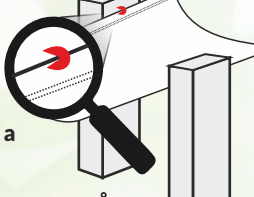

**9**  
At one end pass the wire through the hole in the platform, give a back and attach to the wire



## Fence edge model

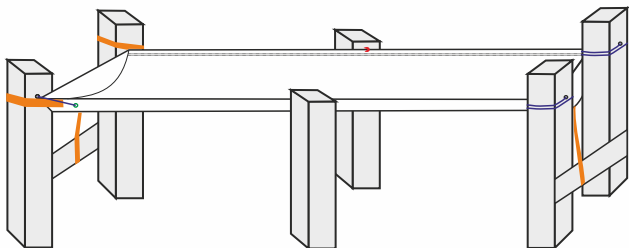

## Half fence model

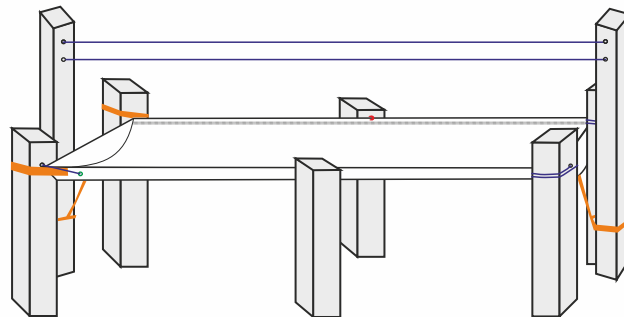

### NOTE:

- For greater durability of the trough, never install it against the floor (reduces useful life by 50%)
- Never cut the fabric or tear it, whenever you need to drill, use the tip of the wire.
- Install against a fence or place wire/cable under the trough to prevent livestock damage.

For very large troughs or on sandy terrain, use a pillow at the ends of the entire trough.